

mm inch

FEATURES

- **Compact DIL type: 20 mm (length) × 10 mm (width) × 12.8 mm (height) (.787×.394×.504 inch)**
- **Excellent in noise resistance**
- **Snubber circuit integrated**
- **High dielectric strength: 2,500 V between input and output**
- **Reverse polarity type available**

TYPES

1. Input module

Type	Output voltage	Input voltage	Part No.
AC input	4 to 32 V DC	80 to 250 V AC	AQCD3-IM 100/240 V AC
DC input	4 to 32 V DC	3 to 32 V DC	AQCD3-IM 4/24 V DC

2. Output module

Type	Load voltage	Input voltage	Part No.
AC output Zero-cross	75 to 125 V AC	5 V DC	AQC1A1 - ZT5 V DC
		12 V DC	AQC1A1 - ZT12 V DC
		24 V DC	AQC1A1 - ZT24 V DC
	75 to 250 V AC	5 V DC	AQC1A2 - ZT5 V DC
		12 V DC	AQC1A2 - ZT12 V DC
		24 V DC	AQC1A2 - ZT24 V DC
AC output Non zero-cross	75 to 125 V AC	5 V DC	AQC1A1 - T 5 V DC
		12 V DC	AQC1A1 - T 12 V DC
		24 V DC	AQC1A1 - T 24 V DC
	75 to 250 V AC	5 V DC	AQC1A2 - T 5 V DC
		12 V DC	AQC1A2 - T 12 V DC
		24 V DC	AQC1A2 - T 24 V DC
DC output	3 to 60 V DC	5 V DC	AQC1AD1- 5 V DC
		12 V DC	AQC1AD1- 12 V DC
		24 V DC	AQC1AD1- 24 V DC

ORDERING INFORMATION

Load current	Load voltage	Type	Input voltage	Input polarity
Nil: Input module 1A: Output module	1: 75 to 125 V AC (Output module) 2: 75 to 250 V AC (Output module) D1: 3 to 60 V DC (Output module) D3: 4 to 32 V DC (Input module)	Nil: DC output IM: Input module T: AC output Non zero-cross ZT: AC output Zero-cross	Output module: 5, 12, 24 V DC Input module: 4/24 V DC, 100/240 V AC	Nil: Standard polarity R: Reverse polarity (Only for output module)

Standard packing: Carton: 50 pcs.; Case: 500 pcs.

SPECIFICATIONS

Rating [at 20°C 68°F; Input voltage ripple (output module) and output voltage ripple (input module): max. 1%]

1. Input module

Item		Type	AC input	DC input	Remarks
			AQCD3-IM 100/240 V AC	AQCD3-IM 4/24 V DC	
Input side	Input voltage		80 to 250 V AC	3 to 32 V DC	
	Input current		Max. 5 mA	Max. 5 mA	
	Pick-up voltage		Max. 80 V AC	Max. 3 V DC	
	Drop-out voltage		Min. 10 V AC	Min. 1 V DC	
Output side	Load voltage		4 to 32 V DC	4 to 32 V DC	
	Load current		0.1 to 25 mA	0.1 to 25 mA	
	Max. "OFF-state" leakage current		Max. 5μA	Max. 5μA	When 32 V DC applied
	Max. "ON-state" voltage drop		Max. 1.6 V	Max. 1.6 V	at max. carrying current

2. Output module

(1) AC output type

Item		Type	AQC1A1-ZT5VDC	AQC1A1-ZT12VDC	AQC1A1-ZT24VDC	AQC1A2-ZT5VDC	AQC1A2-ZT12VDC	AQC1A2-ZT24VDC	Remarks
			AQC1A1-T5VDC	AQC1A1-T12VDC	AQC1A1-T24VDC	AQC1A2-T5VDC	AQC1A2-T12VDC	AQC1A2-T24VDC	
Input side	Input voltage	(5 V type) 4 to 6 V DC	(12 V type) 9.6 to 14.4 V DC	(24 V type) 21.6 to 26.4 V DC	(5 V type) 4 to 6 V DC	(12 V type) 9.6 to 14.4 V DC	(24 V type) 21.6 to 26.4 V DC	See "Data 3".	
	Input impedance (Approx.)	0.3 kΩ	0.8 kΩ	1.8 kΩ	0.3 kΩ	0.8 kΩ	1.8 kΩ		
	Drop-out voltage, min	0.5 V	1.2 V	2.4 V	0.5 V	1.2 V	2.4 V		
Load side	Max. load current	1 A						See "Data 1". Ta = Min. 40°C	
	Load voltage	75 to 125 V AC			75 to 250 V AC				
	Non-repetitive surge current	20 A							
	Max. "OFF-state" leakage current	0.6 m A (When 100 V AC applied)			1.1 m A (When 200 V AC applied)				
	Max. "ON-state" voltage drop	1.6 A							
	Min. load current	10 mA			20 mA				

(2) DC output type

Item		Type	AQC1AD1-5VDC	AQC1AD1-12VDC	AQC1AD1-24VDC	Remarks
			(5 V type) 4 to 6 V DC	(12 V type) 9.6 to 14.4 V DC	(24 V type) 21.6 to 26.4 V DC	
Input side	Input voltage		(5 V type) 4 to 6 V DC	(12 V type) 9.6 to 14.4 V DC	(24 V type) 21.6 to 26.4 V DC	See "Data 3".
	Input impedance (Approx.)		430 Ω	1.2 kΩ	2.8 kΩ	
	Drop-out voltage, min		0.8 V			
Load side	Max. load current		1 A			See "Data 1". Ta = Min. 40°C
	Load voltage		3 to 60 V DC			
	Non-repetitive surge current		1.5 A			
	Max. "OFF-state" leakage current		0.1 m A (When 60 V DC applied)			
	Max. "ON-state" voltage drop		1.6 V			
	Min. load current		1 mA			

Characteristics [at 20°C 68°F; Input voltage ripple (output module) and output voltage ripple (input module): max. 1%]

Input module

Item		Type	AC Input	DC Input	Remarks
Operate time, max.			20 ms	0.5 ms	Input voltage: 24 V DC or 100V AC Output voltage: 24 V DC Output current: 25mA
Release time, max			20 ms	0.5 ms	
Insulation resistance, min.			10 ⁹ Ω between input and output		at 500 V DC
Breakdown voltage			2,500 Vrms between input and output		For 1 minute
Vibration resistance	Functional		10 to 55Hz double amplitude of 3 mm		10 minutes for X,Y, Z, axis
	Destructive		10 to 55Hz double amplitude of 3 mm		1 hour for X,Y, Z, axis
Shock resistance	Functional		Min. 980 m/s ² {100 G}		4 time each for X,Y,Z axis
	Destructive		Min. 980 m/s ² {100 G}		5 time each for X,Y,Z axis
Ambient temperature			-30°C to +80°C -22°F to +176°F		
Storage temperature			-30°C to +100°C -22°F to +212°F		

Output module

Item	Type	AC output		DC output	Conditions
		Non zero-cross	Zero-cross		
Operate time, max.		1 ms	(1/2 cycle of voltage sine wave)+1ms	0.5 ms	
Release time, max.		(1/2 cycle of voltage sine wave)+1ms		1 ms	
Insulation resistance, min.		10 ⁹ Ω between input and output			at 500 V DC
Breakdown voltage		2,500 Vrms between input and output			For 1 minute
Vibration resistance	Functional	10 to 55Hz double amplitude of 3 mm			10 minutes for X,Y, Z, axis
	Destructive	10 to 55Hz double amplitude of 3 mm			1 hour for X,Y, Z, axis
Shock resistance	Functional	Min. 980 m/s ² {100 G}			4 time each for X,Y,Z axis
	Destructive	Min. 980 m/s ² {100 G}			5 time each for X,Y,Z axis
Ambient temperature		-30°C to +80°C -22°F to +176°F			
Storage temperature		-30°C to +100°C -22°F to +212°F			
Operational method		Non zero-cross Turn-ON, Zero-cross Turn-OFF	Zero-cross (Turn-ON and Turn-OFF)	—	

DIMENSIONS (mm inch)

Download [CAD Data](#) from our Web site.

1. Input module (AC, DC)

[CAD Data](#)

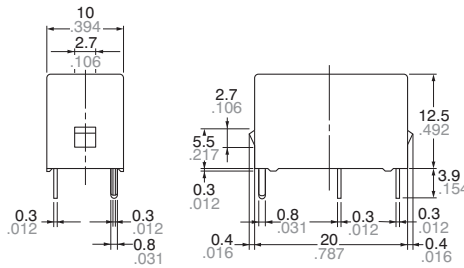

- AC input
 - ⑤ Output: DC-
 - ⑧ Output: DC+
 - ⑩ Input: AC
 - ⑪ Input: AC
 - Case color: Yellow
- DC input
 - ⑤ Output: DC-
 - ⑧ Output: DC+
 - ⑩ Input: DC+
 - ⑪ Input: DC-
 - Case color: White

General tolerance: ±0.5 ±0.020

PC board pattern (Copper-side view)

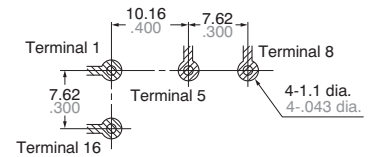

Tolerance: ±0.1 ±0.004

Schematic

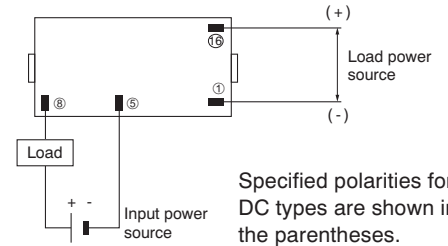

Specified polarities for DC types are shown in the parentheses.

2. Output module (AC, DC)

[CAD Data](#)

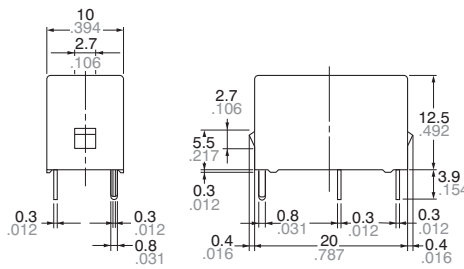

- AC output
 - ⑤ Output: AC
 - ⑧ Output: AC
 - ⑩ Input: DC+
 - ⑪ Input: DC-
 - Case color: Black
- DC output
 - ⑤ Output: DC -
 - ⑧ Output: DC+
 - ⑩ Input: DC+
 - ⑪ Input: DC -
 - Case color: Red

General tolerance: ±0.5 ±0.020

PC board pattern (Copper-side view)

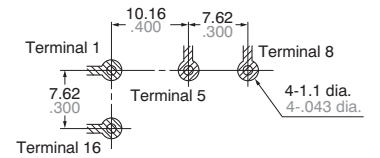

Tolerance: ±0.1 ±0.004

Schematic

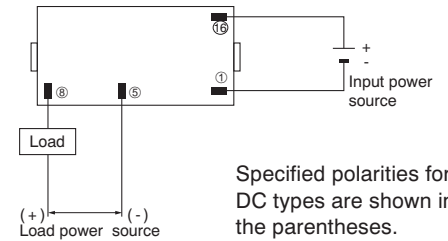

Specified polarities for DC types are shown in the parentheses.



PC1A-PS

REFERENCE DATA

1. Load current vs. ambient temperature

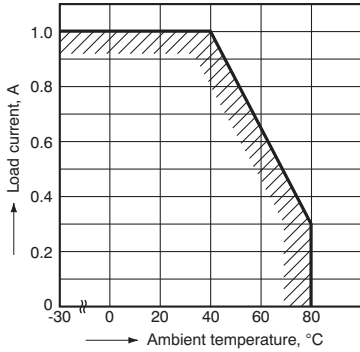

2-(1) Non-repetitive surge current vs. carrying time (AC output)

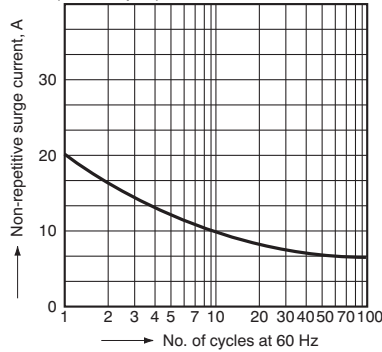

2-(2) Non-repetitive surge current vs. carrying time (DC output)

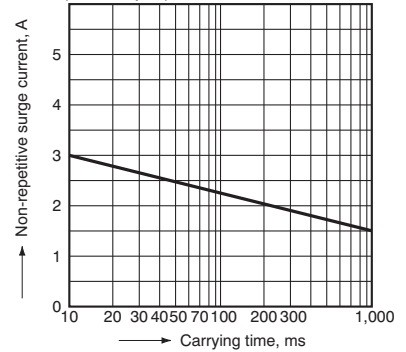

3. Input current vs. input voltage characteristics (AC/DC output)

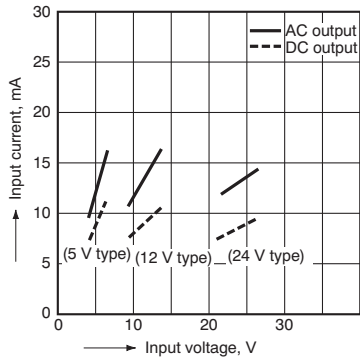

4-(1) Input current vs. input voltage characteristics (AC input)

Tested sample: AQCD3-IM100/240 V AC, 5 pcs.

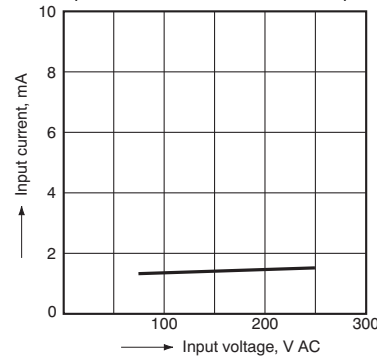

4-(2) Input current vs. input voltage characteristics (DC input)

Tested sample: AQCD3-IM4/24 V DC

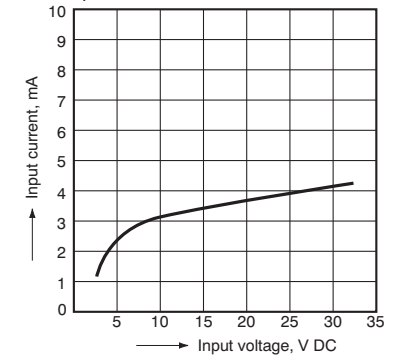

5. Load current vs. ambient temperature characteristics for adjacent mounting

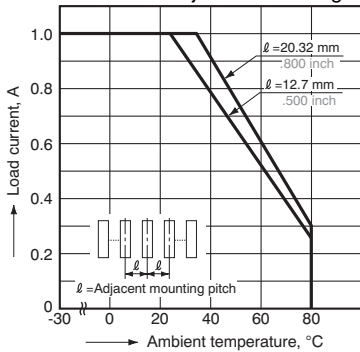

NOTE

When used for the load less than rated

In the case of the load current less than rated, malfunction may result from the residual voltage across the both ends of the load even if the solid state relay is turned off.

Use a dummy resistor as a countermeasure.

The total of the current through the resistor and the load current must exceed the min. rated load current.

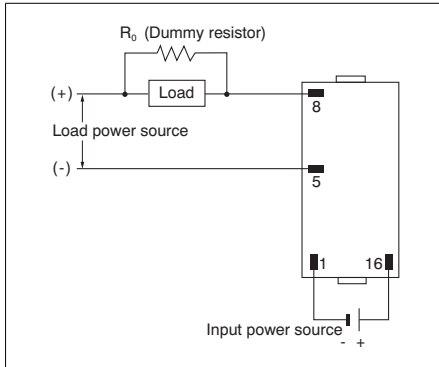

In case the dummy resistor is not used, keep in mind that the residual voltage becomes as follows:

Example:

For the inductive load by the 5 mA load current and the 200 V AC load voltage, the load impedance becomes 40 kW and $V_e/V = 16\%$ is estimated from the below graph.

Accordingly, the 32 V voltage remains across the both ends of the load when the solid state relay is turned off.

- Characteristics of residual voltage vs. load impedance

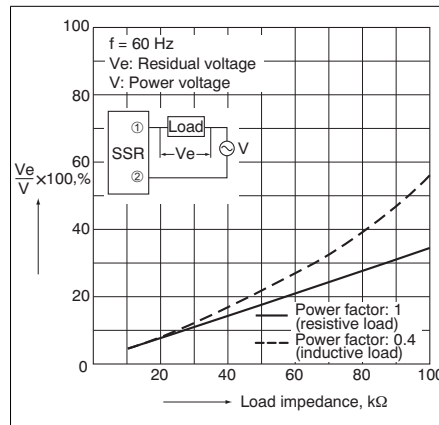

Cautions for Use